

Introduction to The Retina

A.L. Yuille (UCLA).

With some slides from Zhaoping Li (UCL) and other sources.

Part 1: The Retina – basic properties

- Retina as a camera.
- And what else?

Input to visual system

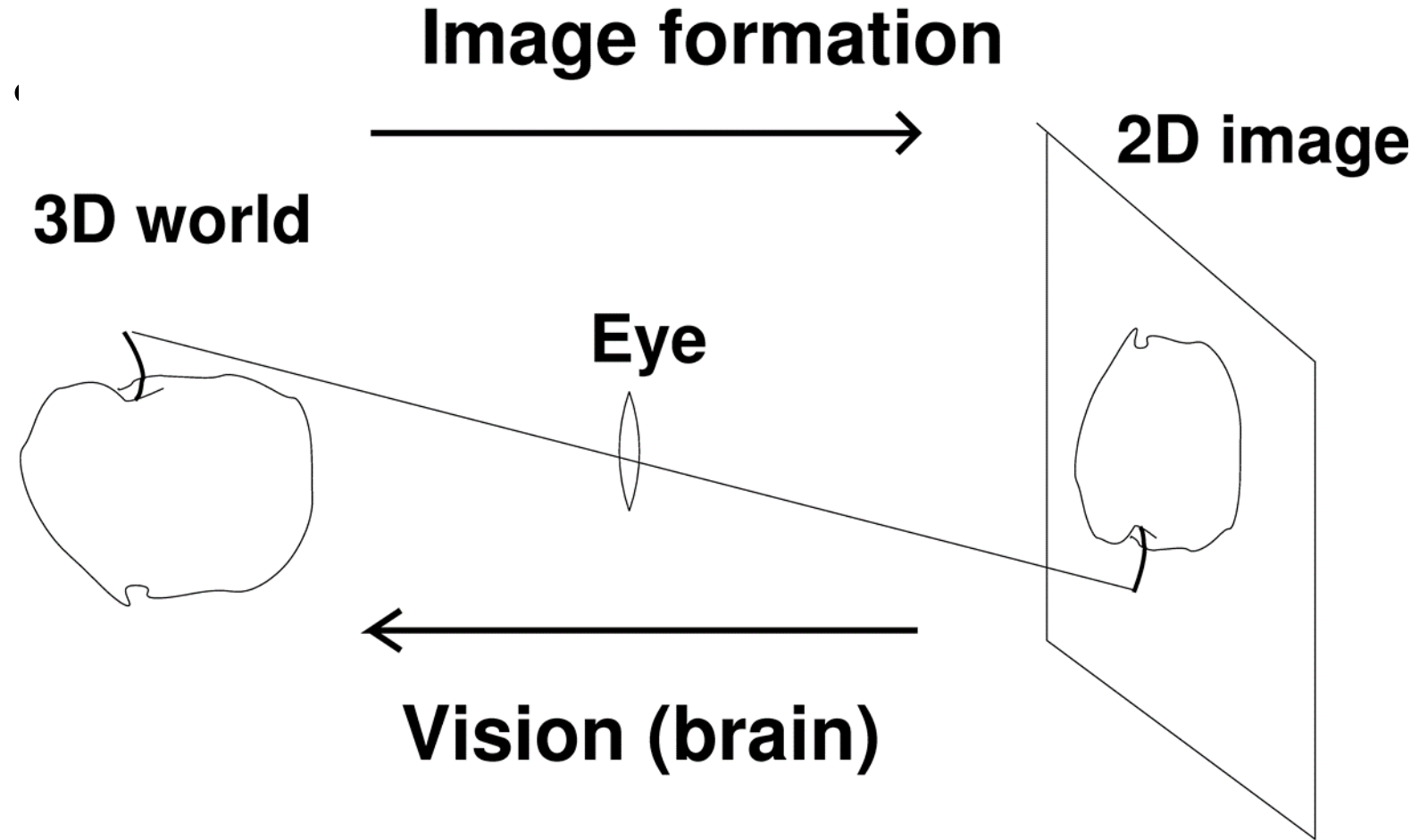

Retina at start of visual hierarchy (V0?)

- Retina – no top-down input:
connects to superior colliculus (SC)
SC controls muscles for gaze control.

A schematic of the visual processing hierarchy

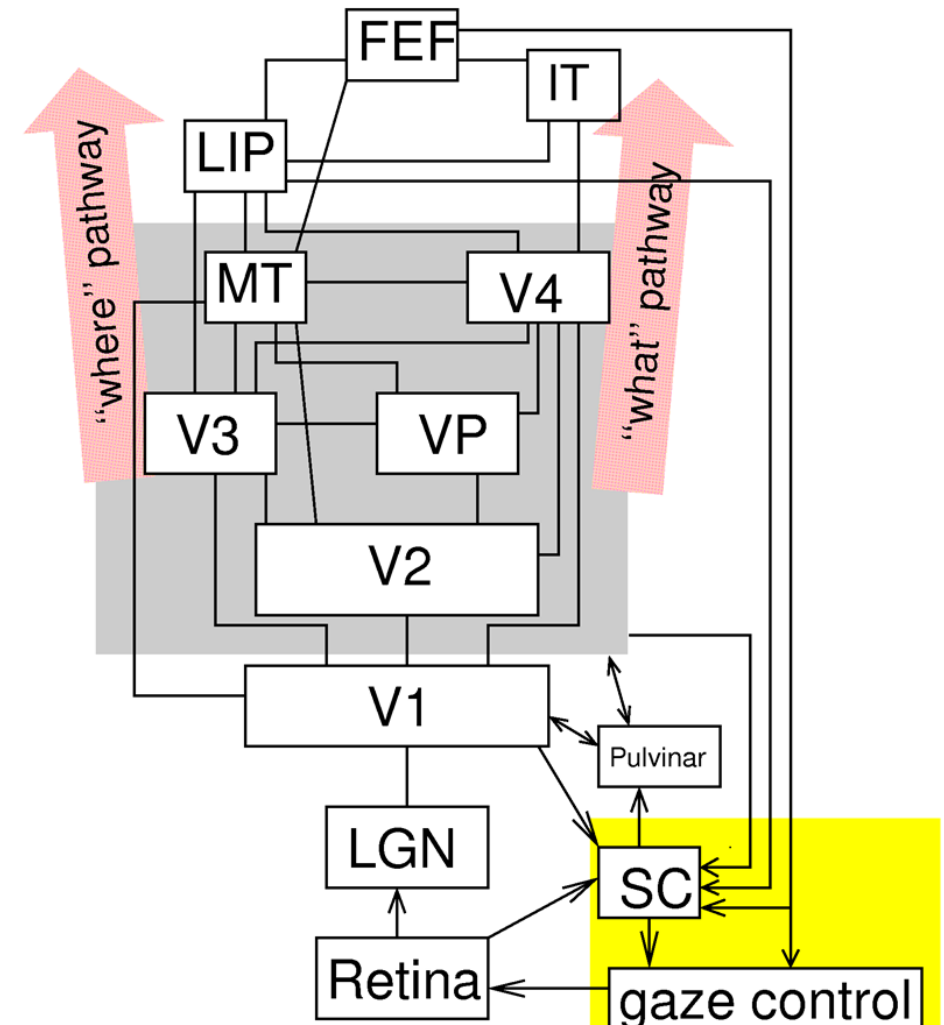

Purpose of the Retina

- Zhaoping Li's picture. Retina captures image and encodes for transmission to LGN (Thalamus) and then to visual cortex V1.

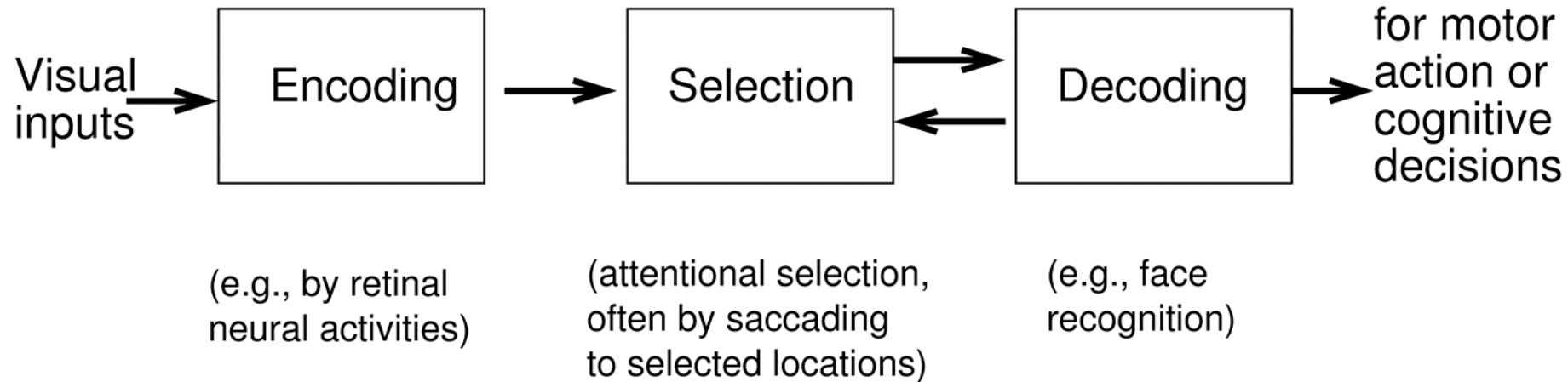

Rapid Eye Movements: saccades, attention

- Eyes are frequently moving (several times a second). Movements take between 20-100 msec (10-3 seconds). Why do humans have consistent perception?

The gaze scan path during the initial (yellow), subsequent (blue and then red), and final (magenta) periods of a search by an observer for a uniquely tilted bar

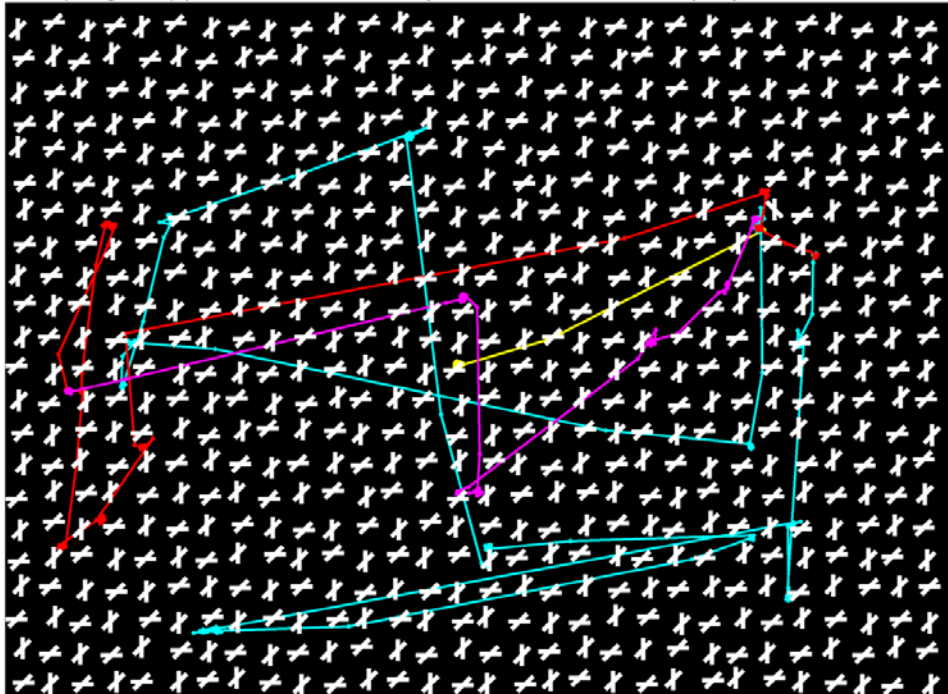

Inattention blindness — spotting the difference between the two images



Inattention blindness — spotting the difference between the two images



Structure of the Eye

- Backwards

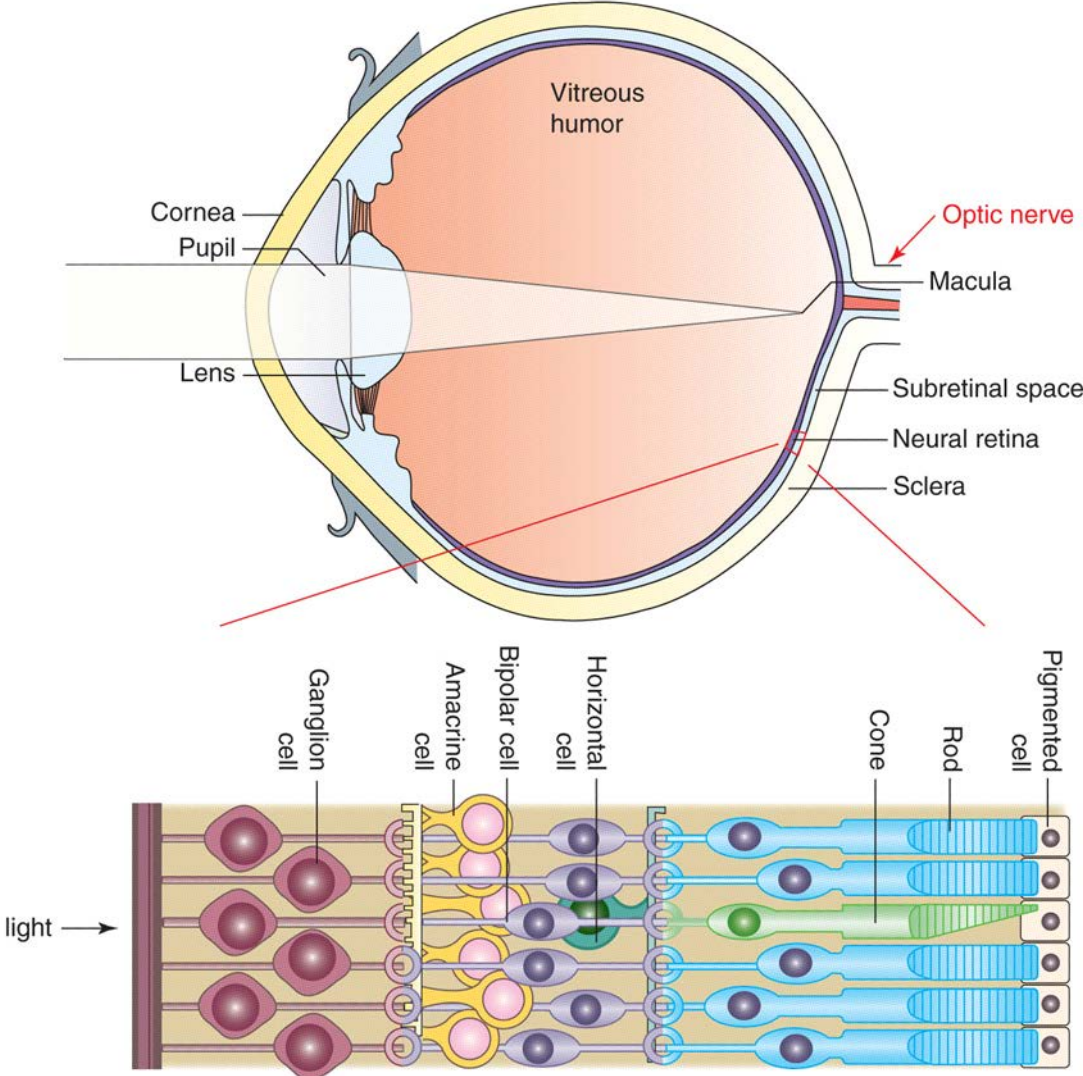
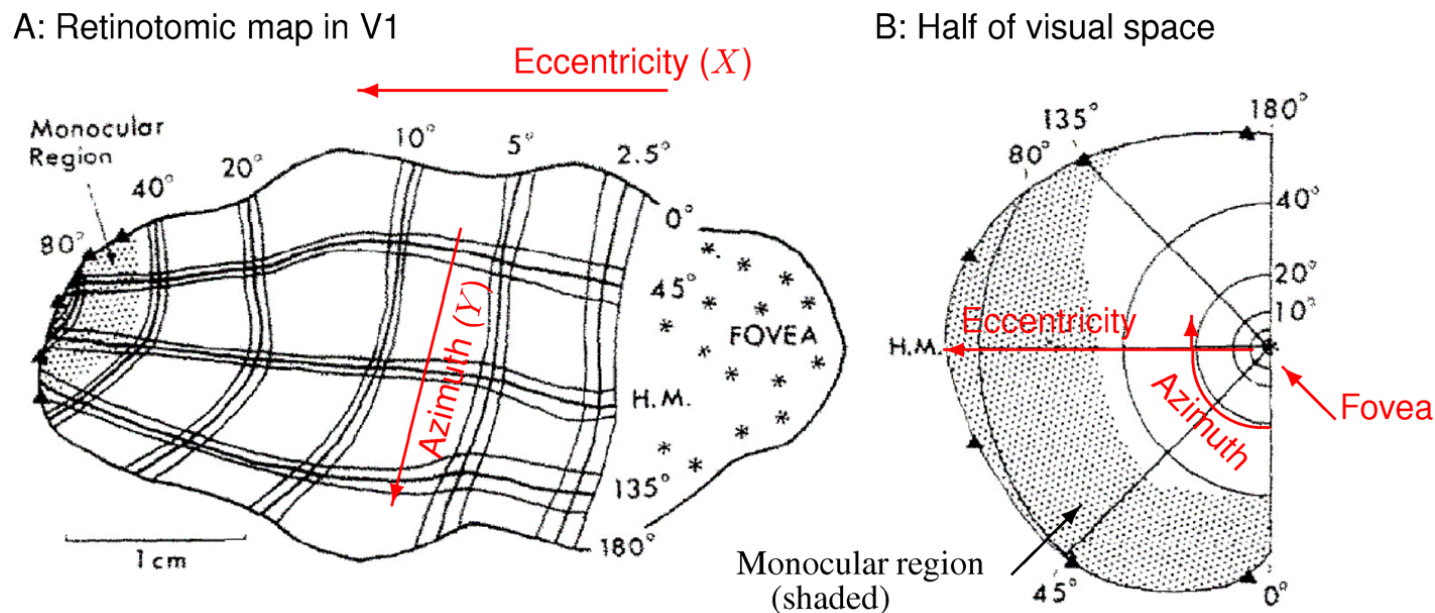

Figure from "Understanding Vision: theory, models, and data", by Li Zhaoping, Oxford University Press, 2014

Retinotopy

- Higher visual areas – e.g., V1, V2 in visual cortex have similar spatial organization to retina. Retinotopy. Test by measuring receptive fields (Clay Reid's lecture).



Part II: Neurons

- Real neurons and neural circuits.

A: A neuron drawn by Cajal

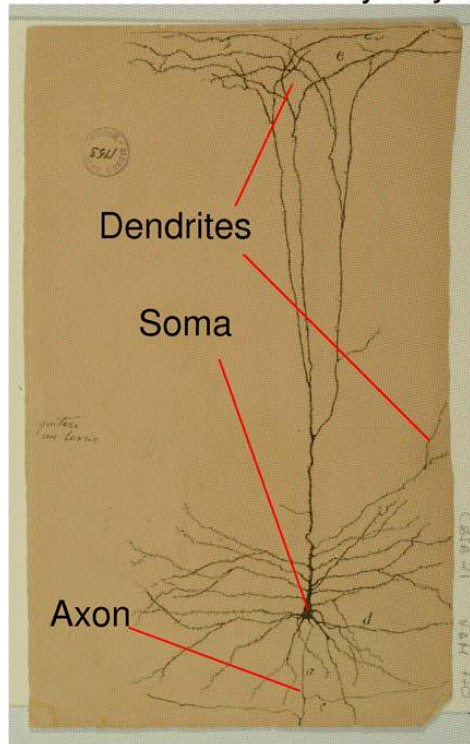

B: Two model neurons linked by a synaptic connection

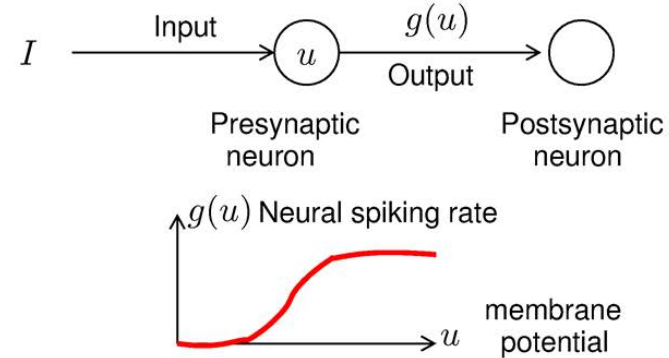

C: A model neural circuit for a brain area

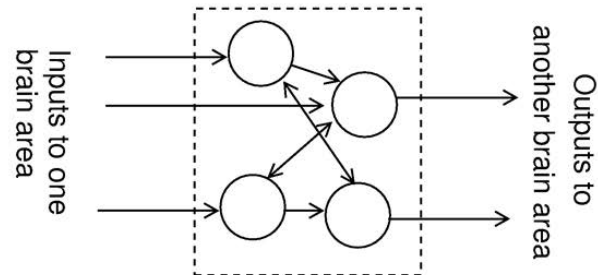

Simple Model of a Neuron

- Simplest model. Integrate and Fire.

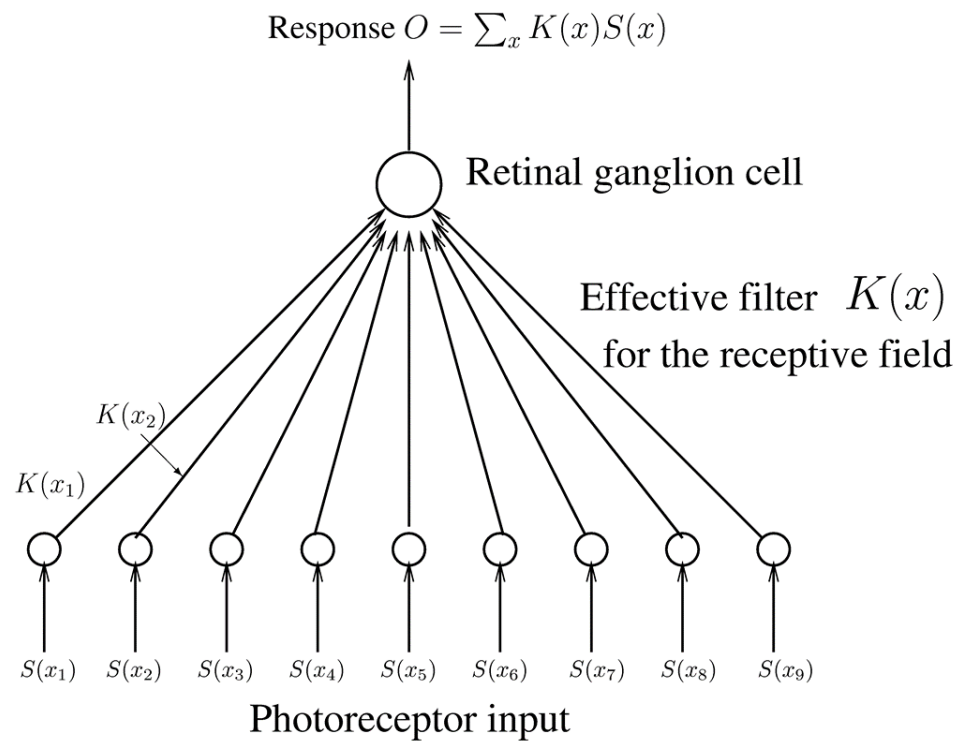

Measuring Receptive Fields

- Electrophysiology

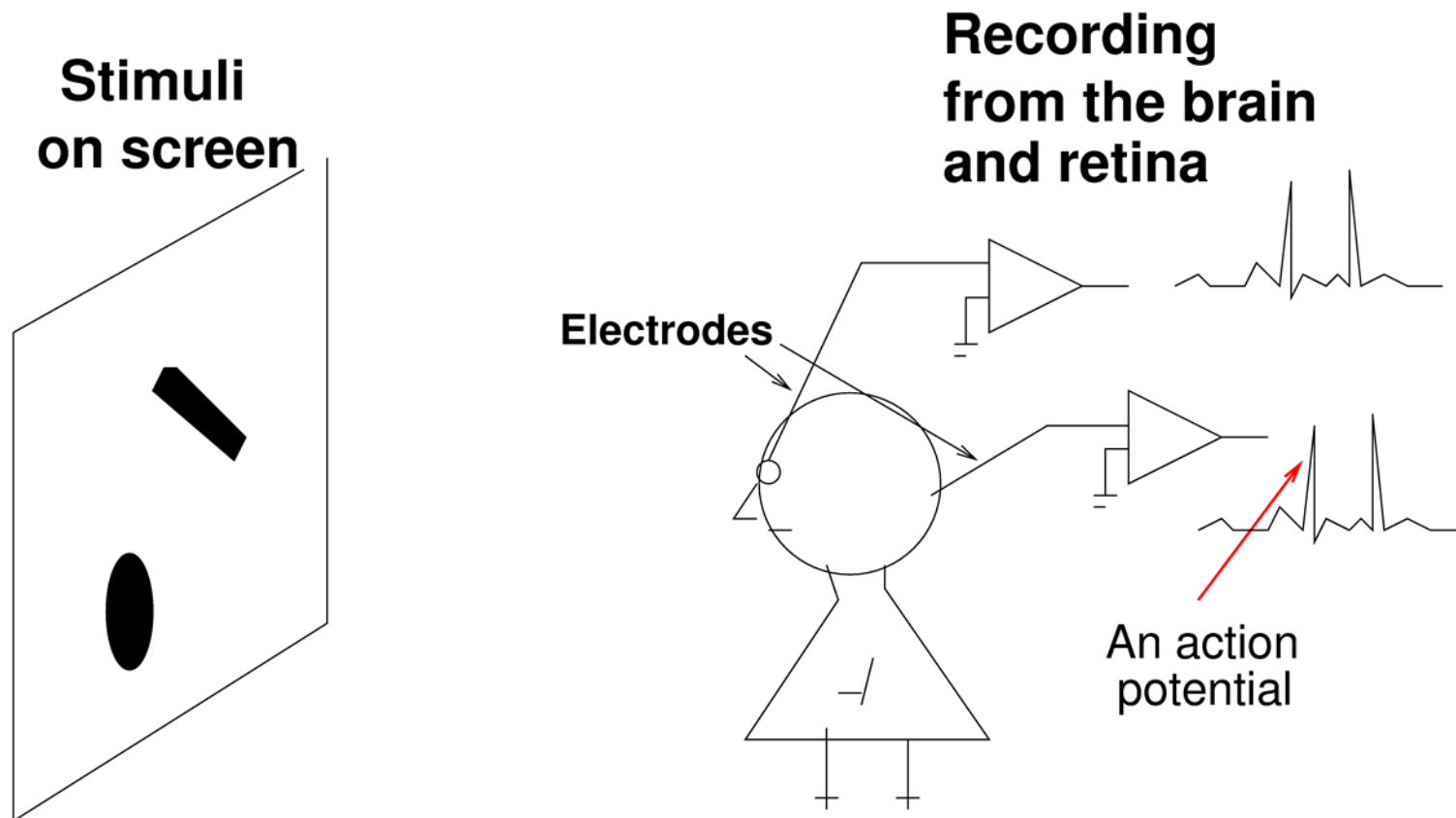

Ganglion Cells: Center Surround Receptive Field

- Mathematical models later.

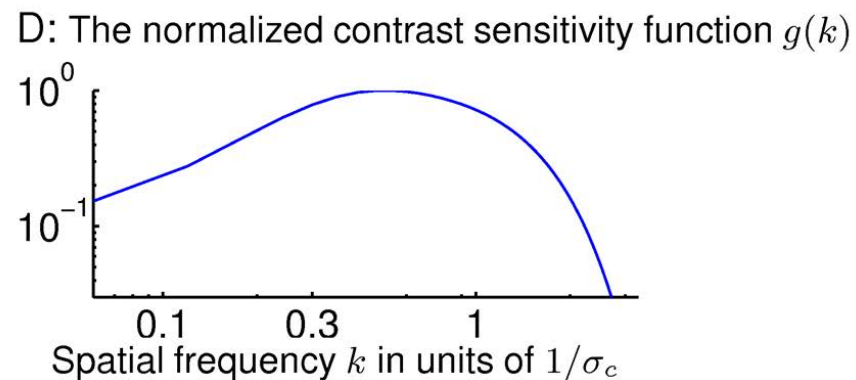
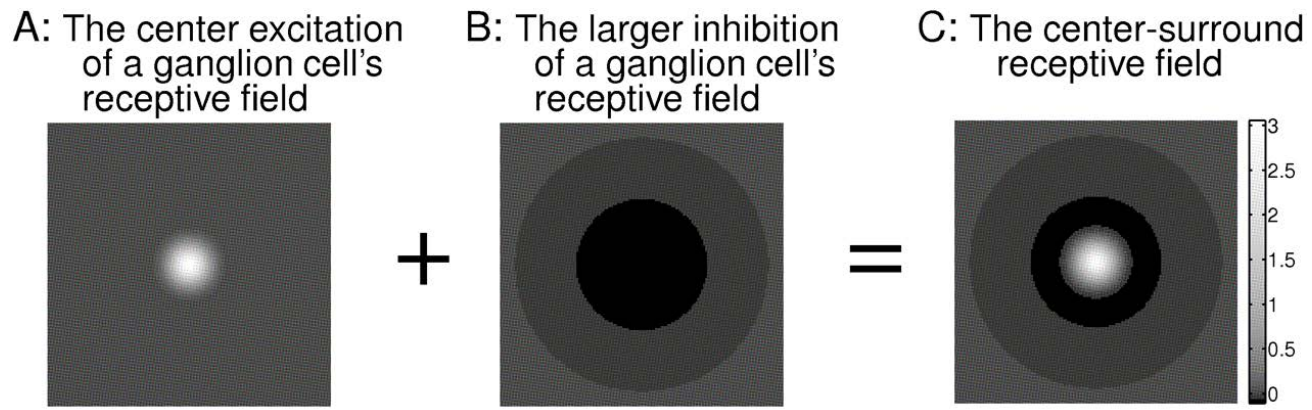

Sensitivity to Color

- Three colors – but some people have two (color blind)

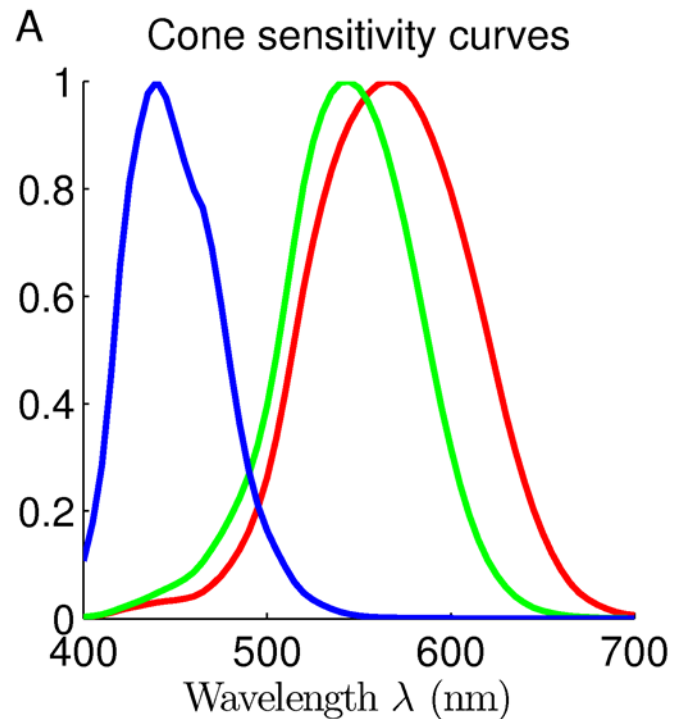

B Color sensitivity of retinal ganglion cells

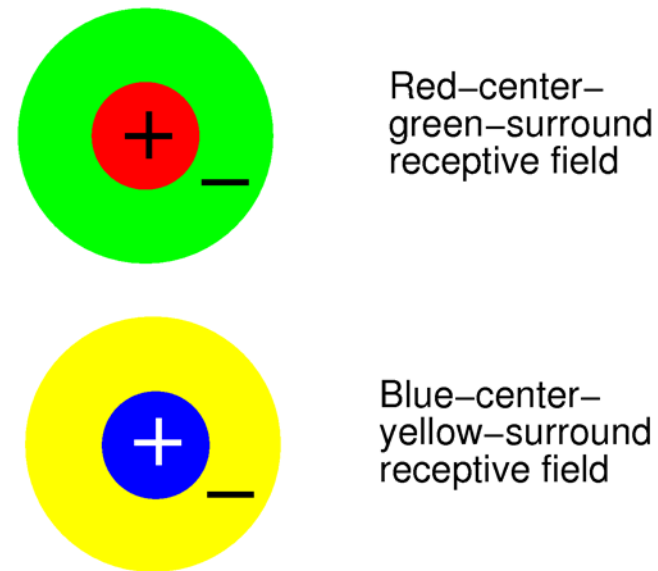

Part 3: Purpose of the Retina

- With about 10 million retinal receptors, the human retina makes on the order of 10 to 100 million measurements per second. These measurements are processed by about a billion plus cortical neurons.
- How sensitive is the eye? What are the limits of vision?
- It can be shown that the retina can be sensitive to a very small number of photons. This is close to theoretical predictions based on the biophysics of neurons (W. Bialek handout).

Purpose of the Retina

- The anatomy and electrophysiology of the retina has been studied extensively – far more deeply than the cortex.
- Their main functions are:
 - (i) Transduce image intensity patterns to patterns of neural activity.
 - (ii) To attenuate slow spatial and temporal changes through spatial and temporal filtering of the image.
 - (iii) Normalize responses – gain control -- to encode contrast and deal with the large range of luminance (intensity) from scene to scene. Ranging from faint starlight to bright sunlight (range of 1 to 10^9).
 - (iv) Encode the intensity so that it can be efficiently transmitted to the LGN and then on the visual cortex.

But is the human retina really that dumb?

- Does the retina of humans/monkeys just capture images and transmit them to the visual cortex? Or does it process them – e.g., by extracting edges. (like the retinas of simpler animals – frogs).
- Standard wisdom: “smart animals have dumb retinas and dumb animals have smart retinas.”
- This is questioned by T. Gollitsch and M. Meister (handout). They argue that human/monkey retinas are more complex than current models suggest. That current models of retinal neurons are based on experimental findings using simple stimuli – and the neurons are more complicated when they see natural stimuli. (We will keep returning to this issue).
- Why use so many neurons if the retina is only a smart camera? But real smart cameras are fairly complex.

Retinal Operations: M. Meister (1)

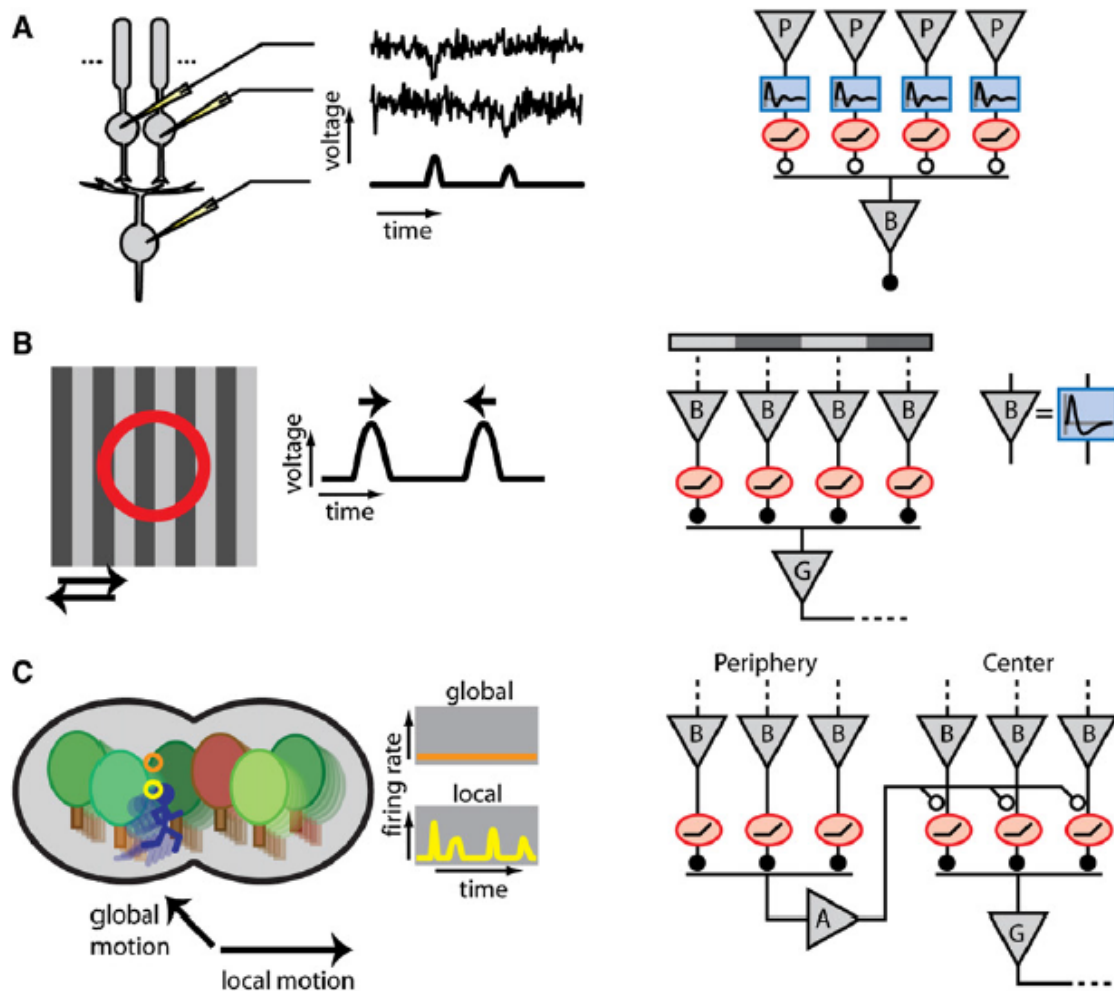

Figure 2. Computations Performed by the Retina and Their Underlying Microcircuits

(A) Detection of dim light flashes in the rod-to-rod bipolar pathway. (Left) Rod bipolar cells pool over many rod photoreceptors, which show distinct responses to single-photon activation embedded in noise. Bipolar cell potentials are not swamped by the accumulated noise in all rods, but instead show distinct activations from single photons, as shown by the voltage traces from a simple model simulation. (Right) The important elements of the corresponding retinal microcircuitry. Each photoreceptor output is sent through a band-pass temporal filter followed by a thresholding operation before summation by the rod bipolar cell (Field and Rieke, 2002). Notation for this and all circuit diagrams: triangle, neuron; rectangle, temporal filter function; oval, instantaneous rectifier; closed/open circle, sign-preserving/inverting synapse.

(B) Sensitivity to texture motion. (Left) Y-type ganglion cells show activation when a fine grating shifts in either direction over the receptive field (circle), even though the average illumination remains constant. (Right) The underlying microcircuit. Each shift of the grating excites some bipolar cells and inhibits others. The bipolar cells have biphasic dynamics (see impulse response in inset) and thus respond transiently. Only the depolarized bipolar cells communicate to the ganglion cell, because of rectification in synaptic transmission. Thus, the ganglion cell fires transiently on every shift (Hochstein and Shapley, 1976).

(C) Detection of differential motion. (Left) An object-motion-sensitive ganglion cell remains silent under global motion of the entire image but fires when the image patch in its receptive field moves differently from the background. (Right) The circuitry behind this computation is based on similar elements as for the Y cell (panel B). Rectification of bipolar cell signals in the receptive field center creates sensitivity to motion. Polyaxonal amacrine cells in the periphery are excited by the same motion-sensitive circuit and send inhibitory inputs to the center. If motion in the periphery is synchronous with that in the center, the excitatory

Retinal Operations: M. Meister (2)

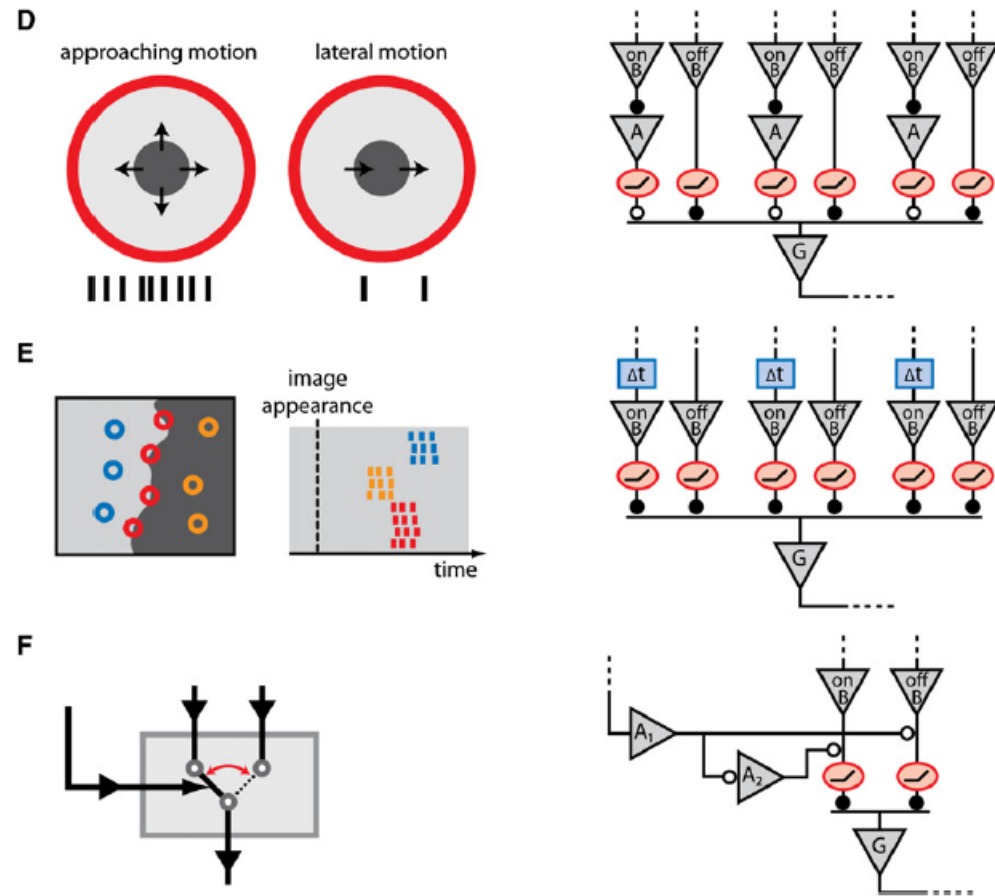

(D) Detection of approaching motion. (Left) A certain type of retinal ganglion cell responds strongly to the visual pattern of an approaching dark object, as indicated by the schematic spike train below, but only weakly to lateral object motion. (Right) The circuit that generates this approach sensitivity is composed of excitation from OFF bipolar cells and inhibition from amacrine cells that are activated by ON bipolar cells, at least partly via gap junction coupling. Importantly, these inputs are nonlinearly rectified before integration by the ganglion cell (Münch et al., 2009).

(E) Rapid encoding of spatial structures with spike latencies. (Left) Specific retinal ganglion cells encode the structure of a new image by their spike latencies. Cells with receptive fields (circles) in a dark region fire early, those in a bright region fire late. Cells whose receptive fields contain both dark and bright produce intermediate latencies and thus encode the boundary in their synchronous firing. (Right) The responses result from a circuit that combines synaptic inputs from both ON and OFF

bipolar cells whose signals are individually rectified. The timing differences in the responses follow from a delay (Δt) in the ON pathway (Gollisch and Meister, 2008a). (F) Switching circuit. (Left) A control signal selectively gates one of two potential input signals. (Right) In the retina, such a control signal is driven by certain wide-field amacrine cells (A_1), which are activated during rapid image shifts in the periphery. Their activation leads to a suppression of OFF bipolar signals and, through a putative local amacrine cell (A_2), to disinhibition of ON bipolar signals (Geffen et al., 2007).

What does a smart camera do?

- Engineers (and computer vision researchers) develop algorithms to enhance photographs and videos. E.g., to adjust color balance, prevent over- and under-exposure.
- Some of these algorithms are quite complex – requiring many of the retinal operations hypothesized by M. Meister. E.g., spatial and temporal grouping.
- C.f. X. Dong, B. Bonev, Y. Zhu, A.L. Yuille. “Region-based temporally consistent video post-processing”. CVPR 2015.

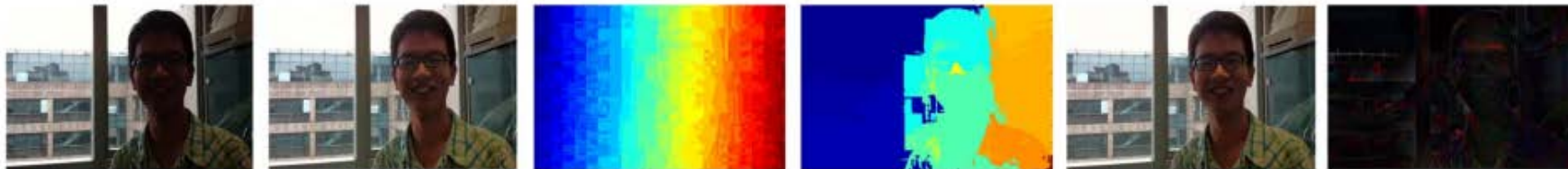

Figure 3. Example of region based reconstruction. Left to right: input map I , original enhancement result E using exposure correction [22], super pixels segmentation result [1], regions merging result, reconstruction result R , and absolute difference between E and R (enlarged in 5 times).

The anatomy of the retina may not be so simple.

- The anatomical structure of the retina gets increasingly complex as scientists study it in detail. S. Seung. Connectonics. (YouTube).
- Many different types of neurons when you consider their detailed anatomy (Masland). Seung recruits volunteers to label the three-dimensional structure of neurons in the retina.
- Scientists who study the visual cortex also find many different types of neurons (hundreds) the more they look into the details. (although many are pyramidal).

The Retina. Complex connections.

- Many different types of neurons – neurons have complex dendritic structure – and complex connections between neurons.

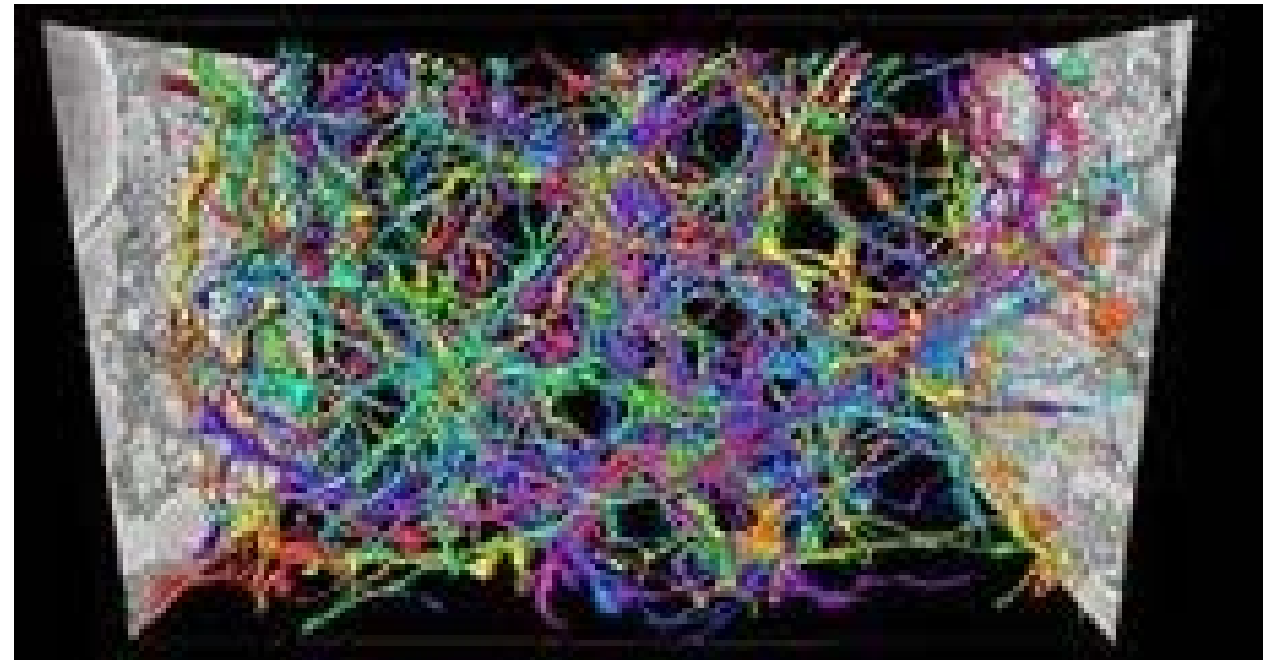
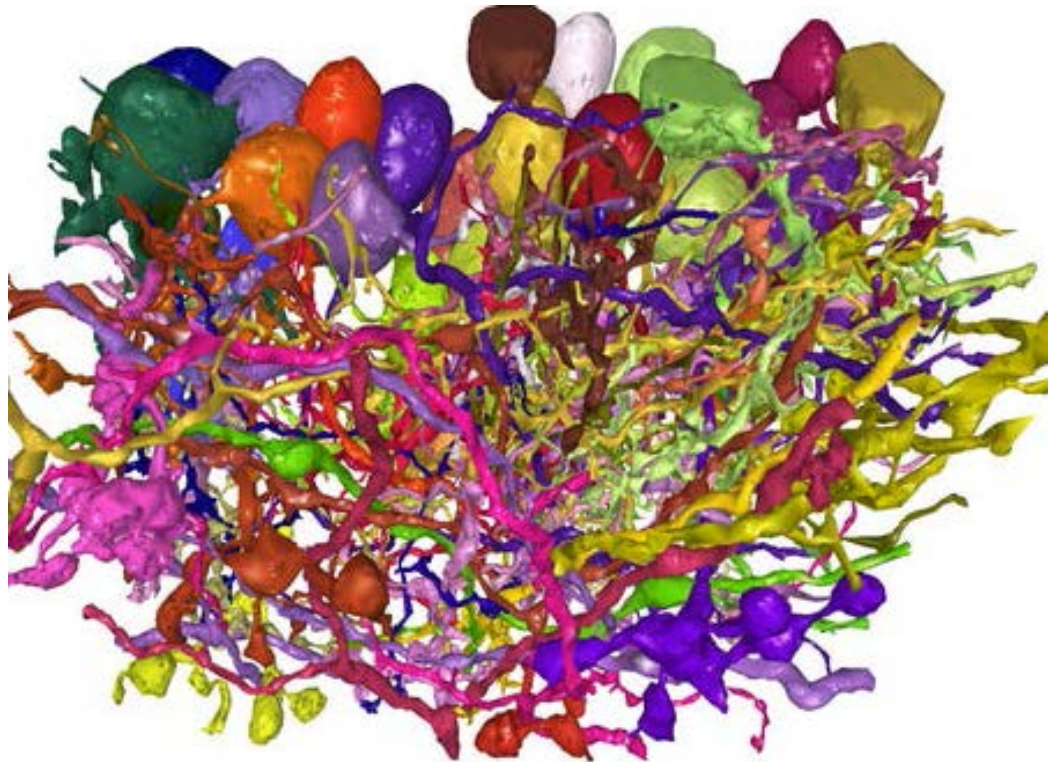

The Retina: Seung. Different types of neurons.

- Neurons: Dendrites, Axons, and Soma (cell body).

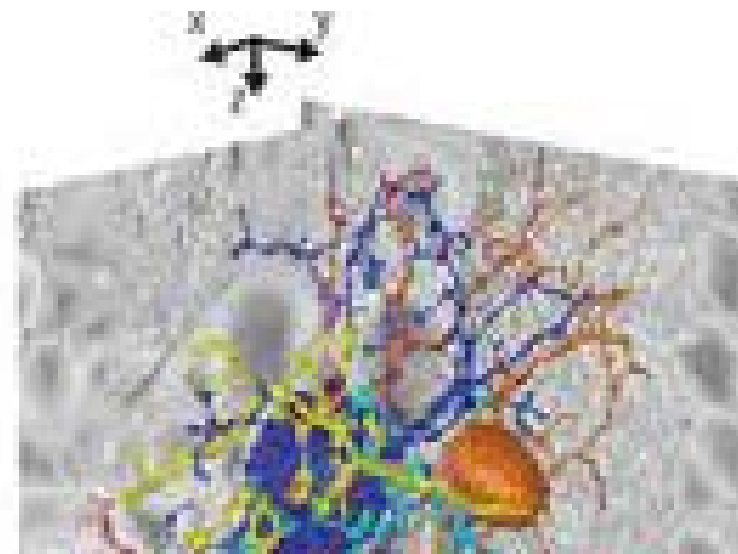
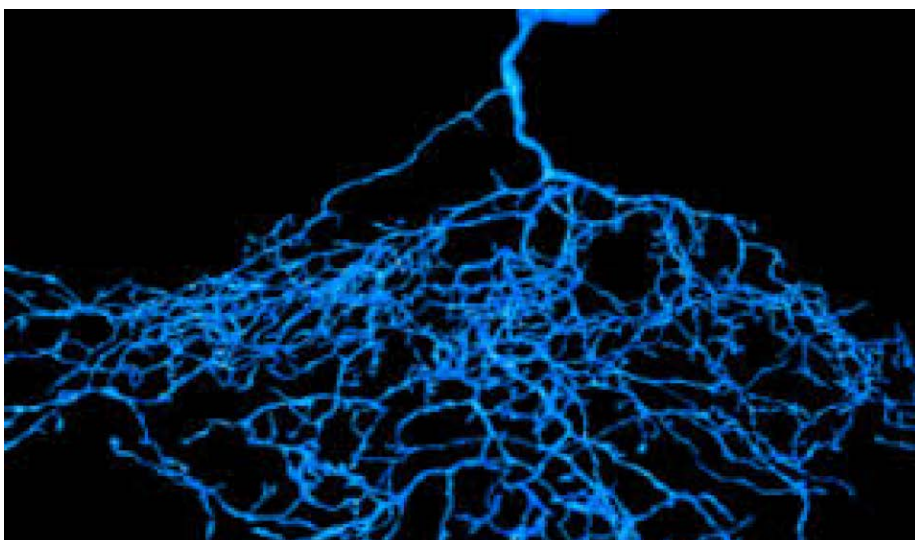
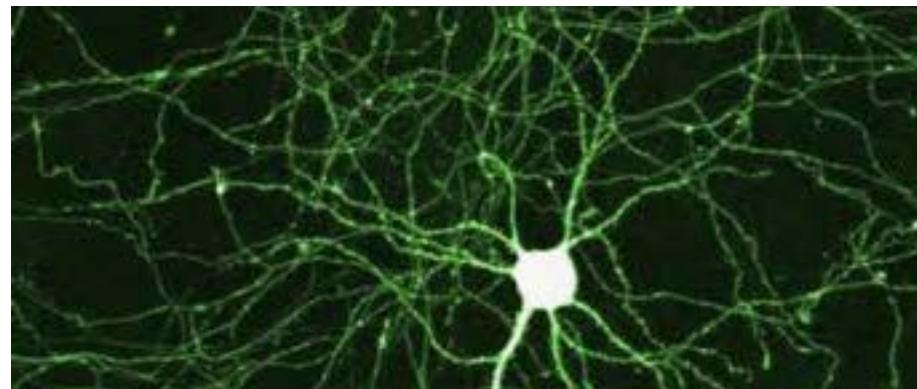
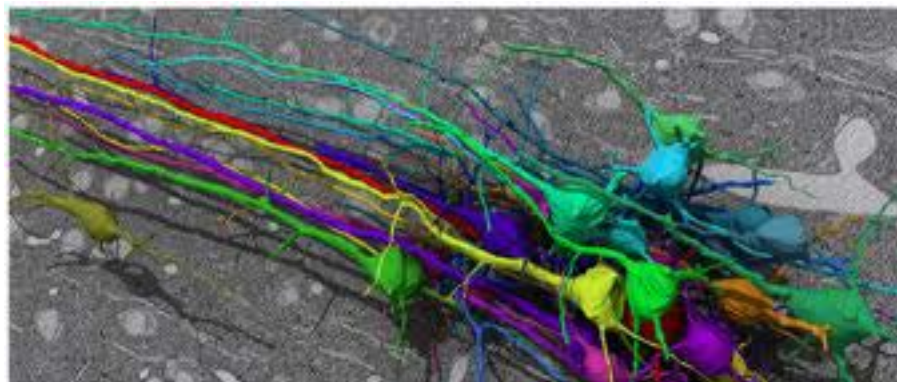

The Retina and Connectonics

- How much will wiring diagrams, or even detailed biophysical models, help understanding the brain.
- Scientists understood the wiring and biophysics of C. Elegans (150 neurons) but this failed to give much insight into the computations performed in its brain. And mice and human/monkey brains are more complicated by many orders of magnitude.
- Surely we have to understand the types of computations being performed as well – it would be hard to understand the function of a TV by just analyzing its electrical circuits – and you certainly could not understand what program it was showing.
- S. Seung and A. Movshon debate: <http://www.youtube.com/watch?v=fRHzkRqGf-g>
- But surely understanding the wiring diagrams and the biophysics is a pre-requisite.

Retina Implants: Artificial Retinas.

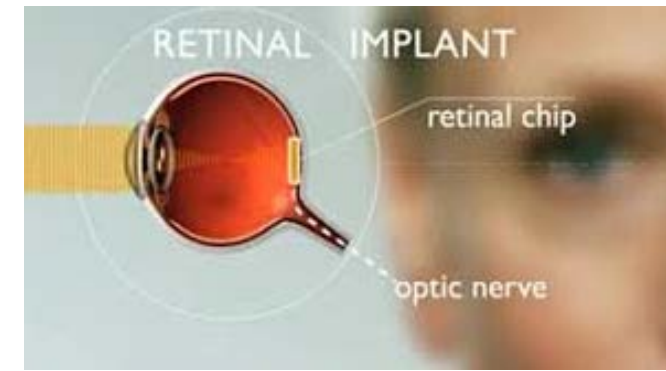

- Retinal implants are intended to help blind people see.
- Current implants 10x10 arrays.
- Prosthetic Eyes; Sheila Nirenberg (TED talk).
- But restoring input to the eye may not enable perception (Mike Mays)

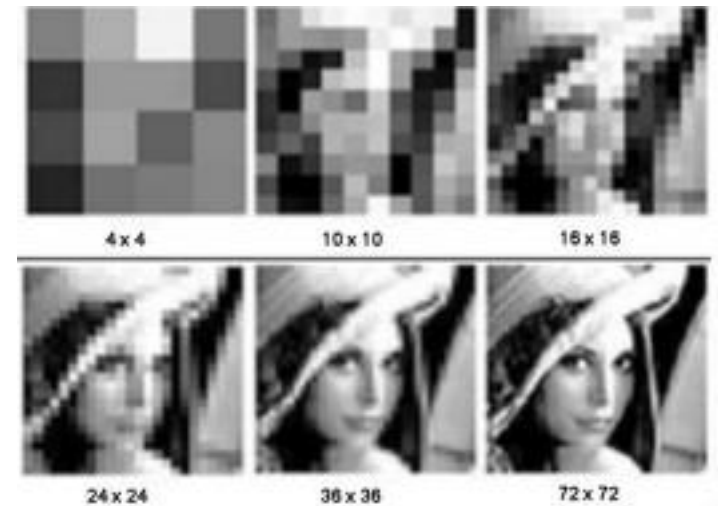
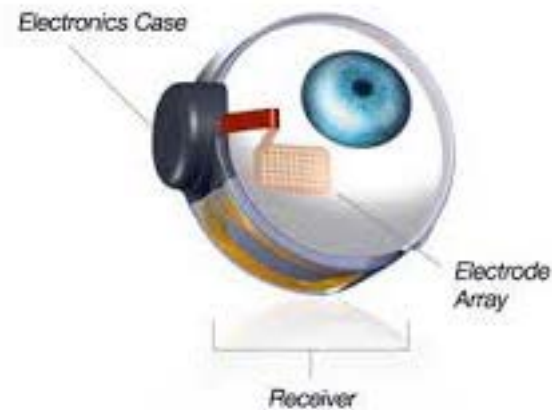
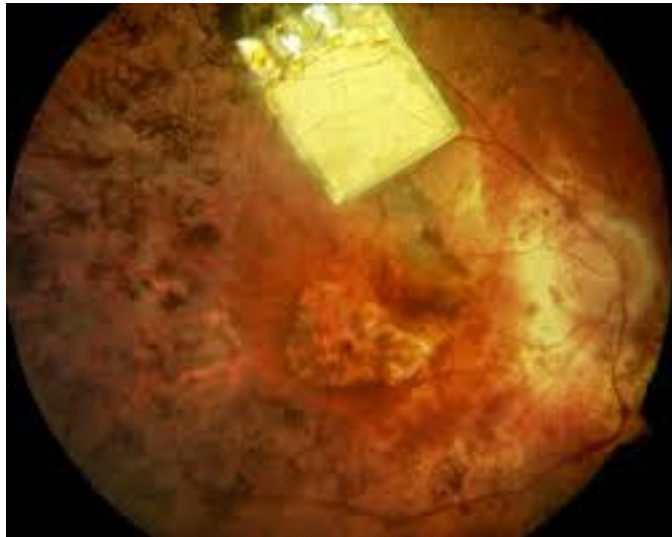

Summary

- There is considerable knowledge about the retina -- Its structure, its purpose, -- but much more to be discovered.